



2294 Old Hwy • Owens Cross Roads, AL 35763

Ph: 256.725.2500 or 866.725.8272

F: 877.333.8272 • WWW.TARAPOOLS.COM

SPECIAL ROMAN END ORDER FORM

Email to: sales@taramfg.com

Date: _____ Due: _____

DISTRIBUTOR

Company: _____

Branch: _____

Contact: _____ Phone: _____

E-Mail: _____

DISTRIBUTOR PO#: _____

SHIPPING INSTRUCTIONS

Branch: Dealer: Pick Up:

Ship Via: _____

DEALER/INSTALLER

Name: _____

Contact: _____ Phone: _____

Address: _____

CITY STATE ZIP

Email: _____

ORDER INFORMATION

Job Name: _____

Pattern: _____

No Tile: Yes

Mixed Tile: Yes

(If Yes) Tile Pattern: _____

Wall Pattern: _____

Floor Pattern: _____

MOUNTING

Beaded: Overlap: Overlap Size: _____

WARRANTY (Please Check One)

Standard: Silver: Gold:

COMMENTS

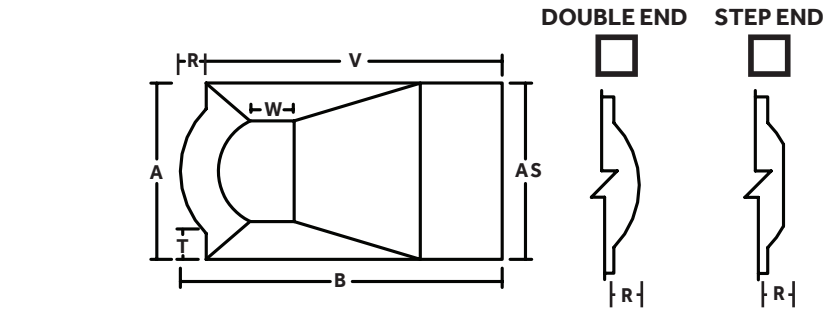

DOUBLE END STEP END

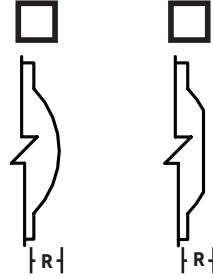

CORNER TYPE



SQUARE



DIAGONAL



RADIUS



90°



Distance

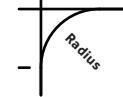

Radius

CORNER SIZE: _____ (ft.) _____ (in.)

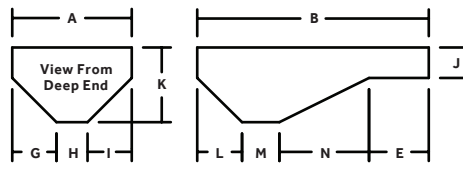

SAFETY LEDGE

_____ (in.)

COVE IN SHALLOW END

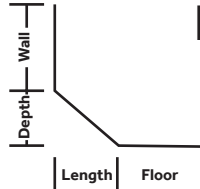

Wall _____ (in.)

Depth _____ (in.)

Length _____ (in.)

MEASUREMENTS

(A): _____ (ft.) _____ (in.) (E): _____ (ft.) _____ (in.)

(B): _____ (ft.) _____ (in.) (N): _____ (ft.) _____ (in.)

(AS): _____ (ft.) _____ (in.) (M): _____ (ft.) _____ (in.)

(V): _____ (ft.) _____ (in.) (L): _____ (ft.) _____ (in.)

(R): _____ (ft.) _____ (in.) (G): _____ (ft.) _____ (in.)

(T): _____ (ft.) _____ (in.) (H): _____ (ft.) _____ (in.)

(W): _____ (ft.) _____ (in.) (I): _____ (ft.) _____ (in.)

(J): _____ (ft.) _____ (in.)

(K): _____ (ft.) _____ (in.)

Self Check
G+H+I=A?
E+L+M+N=B?
STEP RISERS=J?

STEP DETAILS

INDICATE POSITION OF VINYL STEP, IF APPLICABL

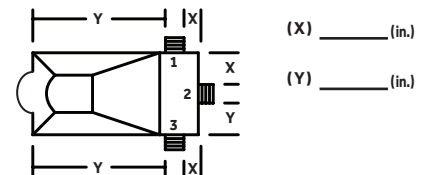
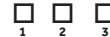

(X) _____ (in.)

(Y) _____ (in.)

IS STEP INSIDE POOL PERIMETER?

YES NO

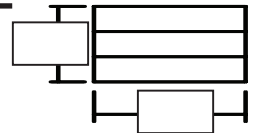

IF STEP IS ACROSS SHALLOW END, IS THE STEP INCLUDED IN (B) LENGTH? YES NO

STEP FASTENER?

(Please choose one. If no boxes are checked we will not add a step fastener)

Rod Pocket Bead Fastener None

STEP FOAM? 1/8" 1/4" None

VINYL STEP

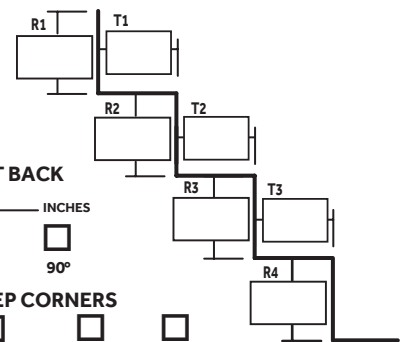

SET BACK

_____ INCHES

45° 90°

STEP CORNERS

RADIUS DIAGONAL 90°

_____ IN. _____ IN.

SureStep: Matching Other

Pattern: _____



2294 Old Hwy • Owens Cross Roads, AL 35763

Ph: 256.725.2500 or 866.725.8272

F: 877.333.8272 • WWW.TARAPOOLES.COM

LINER ORDER CHECKLIST

Email to: sales@taramfg.com

ORDER INFORMATION

- Did you Use a Tara Order Form and Fill it Out Completely?
- What is the Job Name? (We Recommend Using the Homeowners Last Name or Street Address)
- What is the Pattern? (Be Sure to Include mil)

POINT-TO-POINT MEASUREMENTS

- What is the Distance Between Points A and B?
- Did you Indicate the Shallow and Deep End Breakpoints?

POOL DIMENSIONS

- Did you Indicate the Corner Type and Size?
- Did you provide the Wall Height & Deep End Depth?
- Does the Width (A) = G+H+I?
- Does the Length (B) = E+L+M+N?
- Is the Step Radius or Straight on Oval, Radius or Freeform Pool Shape?
- Is the Step Included in the Overall Length or is the Measurement to the Front of the Step?

VINYL COVERED STAIRS

- Did you Include the Location of the Step?
- Did you Include the Step Riser and Tread Measurements?
- Does the Sum of Riser Measurements Equal the Wall Height?
- What Type of Step Fasteners do you Need, Rod Pocket, Bead Fastener or None?
- Is there a Setback?

GRECIAN POOLS

- Is Grecian Out-of-Square? (a point-to-point on a grecian will help prevent errors and only requires 14 points)
- Did you Provide the Hopper Shape?

ROMAN END POOLS

- Did you Include the (W), (R) and (T) Measurements?
- Is it a Single or Double Roman End Pool?

KIDNEY, LAZY "L", TRUE "L" POOLS

- Did you Indicate the Direction of Pool from Shallow End?